

6

5

4

3

2

1



REV	EC No.	DESCRIPTION	Symbol	DATE
A	/	new release	/	Mar.12, 2018

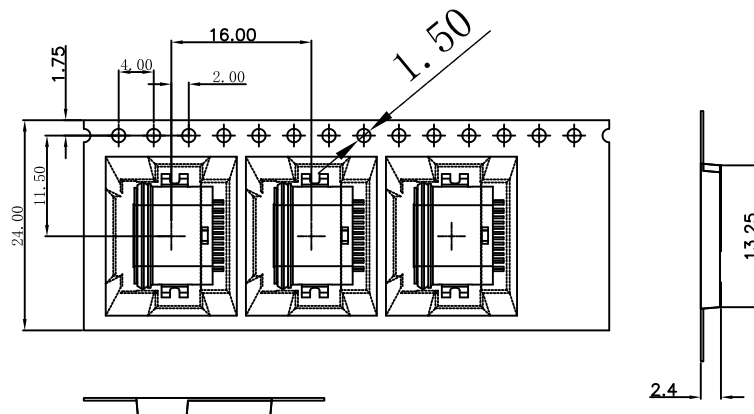

<TABLE 1> PACKAGING QUANTITY

QTY/REEL	REEL/CARTON	QTY/CARTON
700	10	7000

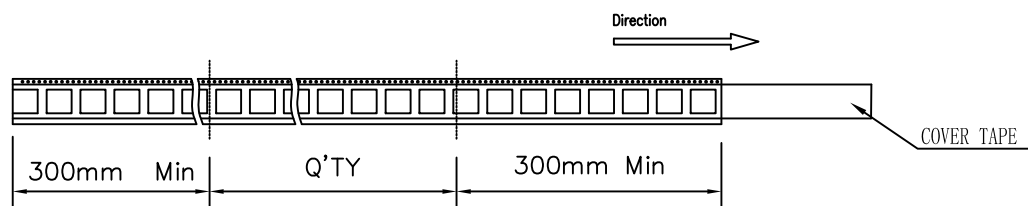
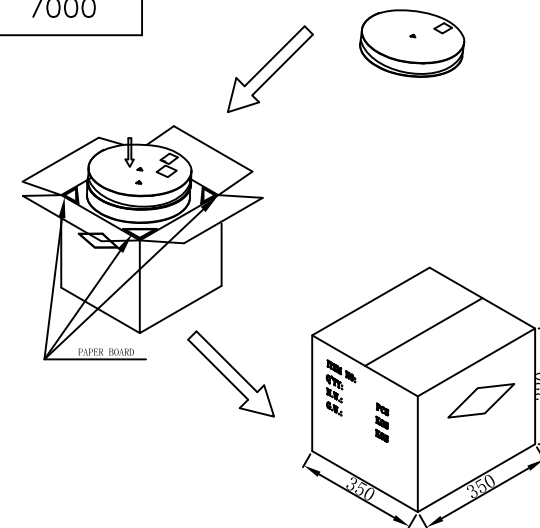

1. TAPE REEL PACKAGE, 700PCS/REEL
2. CARTON SIZE: 350MM*350MM*320MM
3. 7000PCS/CARTON

28.4 REF.

COVER TAPE

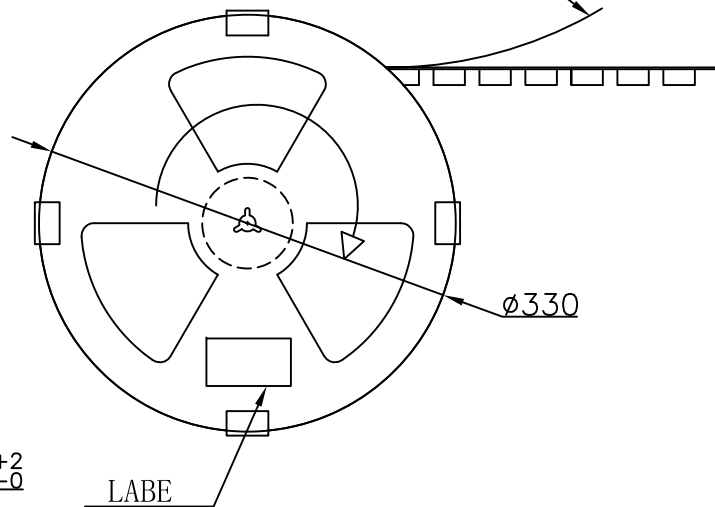

For more information, please feel free to contact Neal. His email is :connmold@foxmail.com Tel:18922965797

WWW.CONNMOLD.COM

DIMENSION UNITS	TOLERANCE
MM	X±0.50 .XX±0.25
	.X±0.35 .XXX±0.15

ConnMold

PART NAME USB TYPE C 16PIN MID-MOUNT
1.40MM WATERPROOF IP67

DRWN:Robert Mar 12,2018

CHK'D:Yuri Mar 12,2018

APPR:Linda Mar 12,2018

PART NUMBER CMWUC661005 REVISION A

THIRD ANGLE PROJECTION

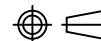

CUSTOMER P/N

/

CUSTOMER GENERAL MARKET

SHEET NUMBER

2 OF 2

6

5

4

3

2

1