

REV	EC No.	DESCRIPTION	Symbol	DATE
A	/	new release	/	Oct.12, 2021

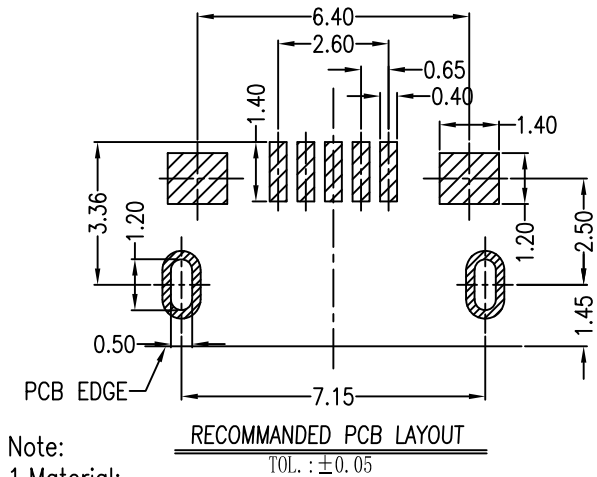
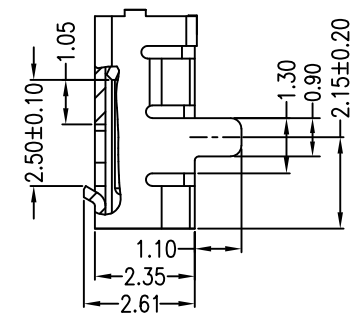
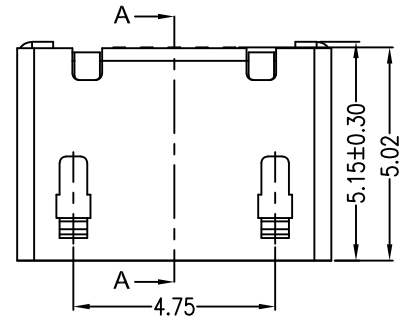
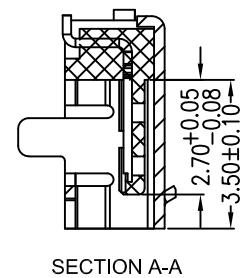
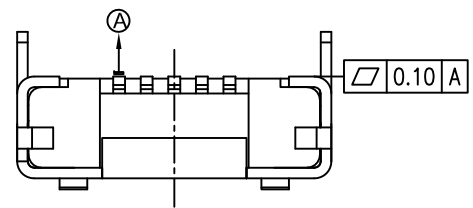

- Note:
- 1.Material:
- 1.1 Housing: High temperature thermoplastic with g.f,UL94v-0
  - 1.2 Contact: copper alloy,t=0.15mm,Gold flash
  - 1.3 Shell: copper alloy,t=0.25mm, matt tin
- 2.Specification:
- 2.1 Current rating:1,5PIN 1.8A Max/2,3,4PIN 1A Max.
  - 2.2 Dielectric withstanding voltage: 100 V(ac) for 1 min.
  - 2.3 Contact resistance: 30 mΩ Max.
  - 2.4 Insulation resistance: 100 MΩ Min.
  - 2.5 Total mating force: 3.57 Kgf Max.
  - 2.6 Total unmating force: 1.0 Kgf Min.
  - 2.7 Temperature range: -40°C~85°C
- 3.Package: tape reel, 1000PCS/Reel

MICRO USB B TYPE PIN ASSIGNMENTS

Contact Number	Signal Name	Remarks
1#	VBUS	Power
2#	D-	Date-
3#	D+	Date+
4#	ID	Reserve or Gound
5#	GND	Gound

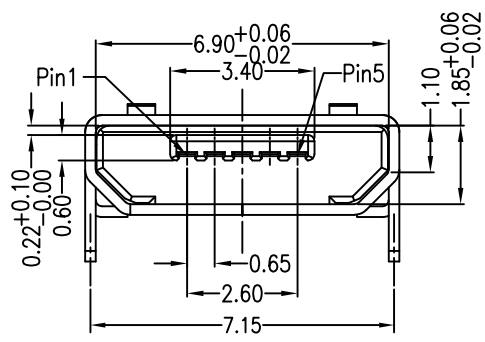
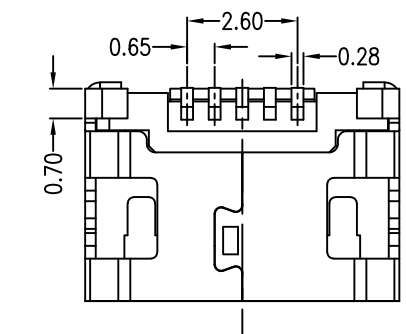

For more information, please help to contact: connmold@foxmail.com. Tel.:18922965797			
WWW.CONNMOLD.COM		ConnMold	
DIMENSION UNITS	TOLERANCE		
MM	X±0.50 .XX±0.25 .X±0.35 .XXX±0.15	PART NAME micro usb b type socket	
DRWN:Robert	Oct.12,2021	7.15mm W/O flange W/O positioning	
CHK'D:Yuri	Oct.12,2021	PART NUMBER	REVISION
APPR:Linda	Oct.12,2021	CMMCF661006	A
THIRD ANGLE PROJECTION	CUSTOMER P/N	CUSTOMER	SHEET NUMBER
	/	GENERAL MARKET	1 OF 1