

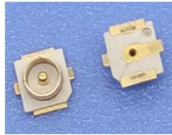







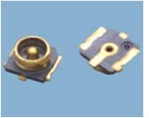

CM technology Co.,LTD---20250310 version D2

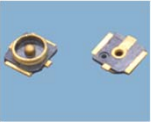
Dongguan Kangmo Electronics Co.,LTD

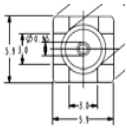
Connmold engineer immerse into this field for about 20years. Please help to contact:neal@connmold.com www.connmold.com

Item	Part number	photo	Description	Package	?pcs/Reel	Compatible with A	A company photo	A company part number
1	CMRFA661001		RF Coaxial Connector Receptacle I	tape reel	5000	I-PEX		20279-001E-01
2	CMRFA661003		RF Coaxial Connector Receptacle III	tape reel	3000	I-PEX		20369-001E-01
3	CMRFA661004		RF Coaxial Connector Receptacle IV	tape reel	3000	I-PEX		20449-001E-01
4	CMRFA661014A		MCX RECEPTACLE SURFACE MOUNT	PE bag	1000	motorola		09C09901V
5	CMRFA661015A		MSR Third RF switch connector	tape reel	3000	murata		MM8030-2610RK0
6	CMFAK661009		Dual row R/A header assembly	tray	200	Molex		348302001
7	CMFAK661010		3pin connector	tray	50	NEUTRIK		NC3FAH2-0

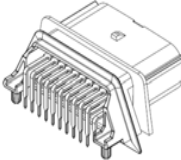
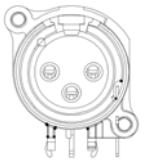
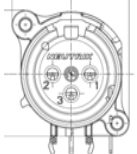
CM technology Co.,LTD---20250310 version D2

Dongguan Kangmo Electronics Co.,LTD







Connmold engineer immerse into this field for about 20years. Please help to contact:neal@connmold.com www.connmold.com

Item	Part number	photo	Description	Package	?pcs/Reel	Compatible with A	A company photo	A company part number
8	CMFAK661012		rectangular power 35contacts , right angle connector	tray	50	TE		776163-1
9	CMFAK661017E		AirMax VSE R/A Receptacle assembly 3pair, 72 positions, 8 imla, 16mm	tray	20	Amphenol		10122263-101LF
10	CMDCZ661012		battery Black	tray	4000	TE		1775485-1
11	CMDCZ661013		battery Black	tray	4000	TE		1-1775485-1
12	CMDCZ661014		battery Black	tray	4000	TE		2-1775485-1
13	CMWUC661001		usb type c waterproof type 6pin IP66	tape reel	700	Molex		2171770001
14	CMWUC661002		usb type c waterproof type 6pin IP66	tape reel	700	Molex		2171760001

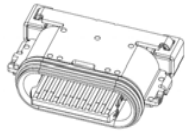
CM technology Co.,LTD---20250310 version D2

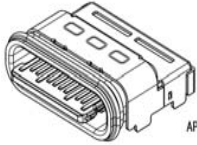
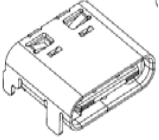
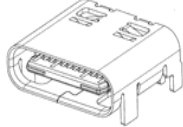
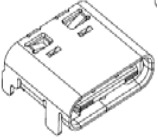
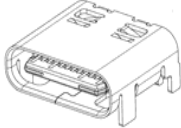
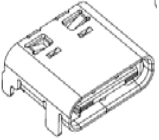
Dongguan Kangmo Electronics Co.,LTD

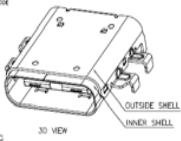
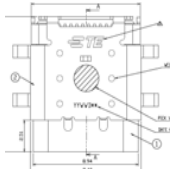
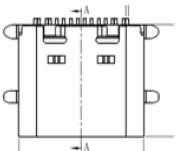





Connmold engineer immerse into this field for about 20years. Please help to contact:neal@connmold.com www.connmold.com

Item	Part number	photo	Description	Package	?pcs/Reel	Compatible with A	A company photo	A company part number
15	CMWUC661030		usb type c waterproof type 24pin IP67	tape reel	1500	Amphenol		3410-3CJWLCA2KR
16	CMWUC661034		usb type c waterproof type 24pin IP67	tape reel	800	JAE		DX07WH24JA3
17	CMUCF661001		usb type c SMT female type shell dip length is 0.50mm	tape reel	900	Molex		1054500111
18	CMUCF661002		usb type c SMT female type shell dip length is 0.80mm	tape reel	900	Molex		1054500101
19	CMUCF661003		usb type c SMT female type shell dip length is 1.30mm	tape reel	900	Molex		1054500121
20	CMUCF661018		usb type c SMT Receptacle type MID-MOUNT shell dip hybrid type	tape reel	800	TE		2129691
21	CMUCF661020		USB type c receptacle for usb 2.0 SMT type,PCB top mount	tape reel	1000	GCT		USB4110

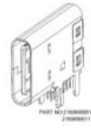
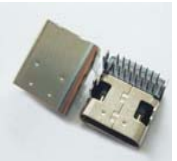
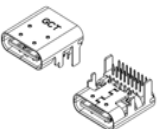
CM technology Co.,LTD---20250310 version D2

Dongguan Kangmo Electronics Co.,LTD

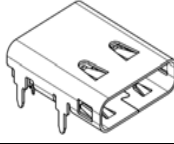

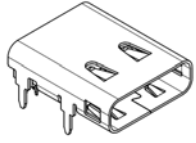
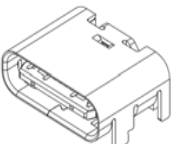
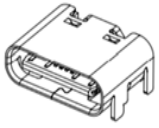
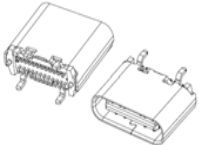
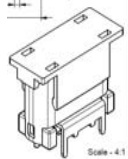





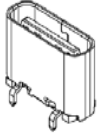

Connmold engineer immerse into this field for about 20years. Please help to contact:neal@connmold.com www.connmold.com

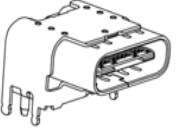
Item	Part number	photo	Description	Package	?pcs/Reel	Compatible with A	A company photo	A company part number
22	CMUCF661023A		usb type c all dip upright type 14pin	tray	1000	Molex		2169890001
23	CMUCF661025		usb type c DIP female type Side entry all through hole type 14pin	tape reel	700	GCT		USB4085
24	CMUCF661027		usb type c SMT female type Side entry 24pin	tape reel	450	GCT		USB4200-03-A
25	CMUCF661045		usb type c DIP female type SMT+DIP 24pin	tape reel	700	Wurth		632723100011
26	CMUCF6610451		usb type c DIP female type SMT+DIP 24pin	tape reel	700	Wurth		632723300011
27	CMUCF661049		usb type c 16pin SMT female type	tape reel	1000	Molex		2171790001
28	CMUCF661063		USB 3.1 Vertical SMT	tape reel	600	Wurth		632722110112

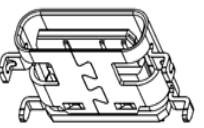
CM technology Co.,LTD---20250310 version D2

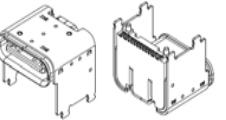
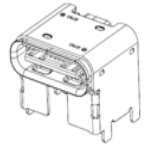
Dongguan Kangmo Electronics Co.,LTD

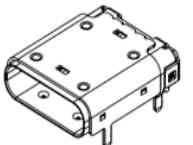







Connmold engineer immerse into this field for about 20years. Please help to contact:neal@connmold.com www.connmold.com

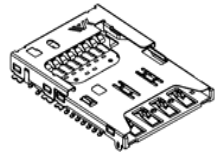
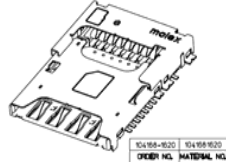

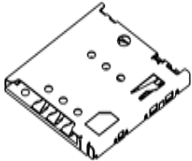

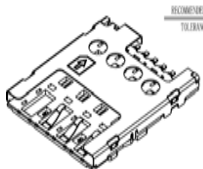
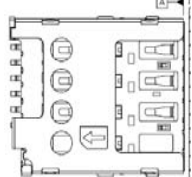



Item	Part number	photo	Description	Package	?pcs/Reel	Compatible with A	A company photo	A company part number
29	CMUCF661064A		usb type c 16pin vertical female type H=6.5mm	tape reel	600	GCT		USB4120-03-C
30	CMUCF661064A		usb type c 16pin vertical female type H=6.5mm	tape reel	600	molex		2171820001
31	CMUCF661068		usb type c 24pin vertical RECEPTACLES standoff 5.50mm	tape reel	550	Wurth		632722200212
32	CMUCF661094D		usb type c 16pin right angel RECEPTACLES CH=0.58	tape reel	1000	molex		2169900003
33	CMUCF661098A		usb type c 16pin RECEPTACLES standoff 4.32mm	tape reel	600	Molex		2171800001
34	CMUCF661101A		usb type c 24pin vertical Receptacle type	tape reel	320	Molex		2047110001
35	CMUCF661102A		USB TYPE C 24pin SMT socket	tape reel	1000	Amphenol		12401610E4#2A



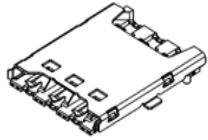

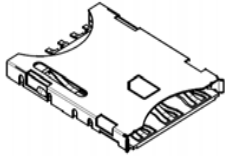

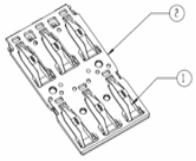

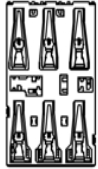
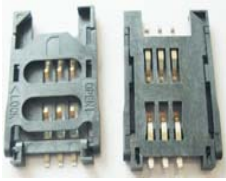
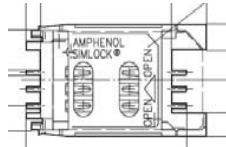
CM technology Co.,LTD---20250310 version D2

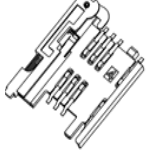

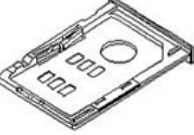

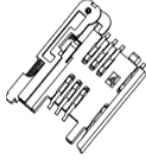
Dongguan Kangmo Electronics Co.,LTD

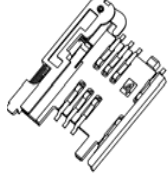

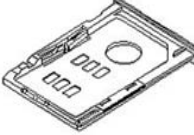
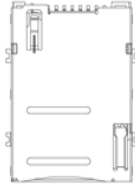
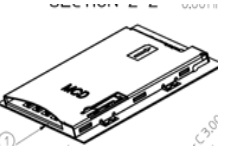

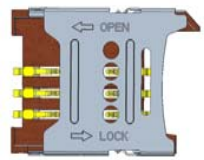

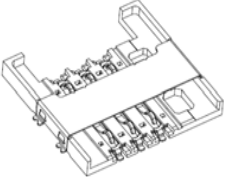
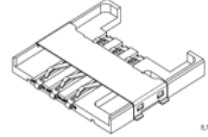
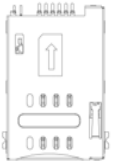
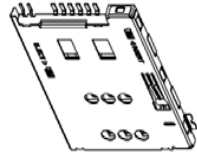
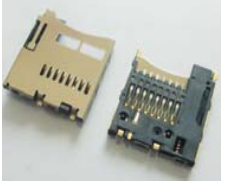
Connmold engineer immerse into this field for about 20years. Please help to contact:neal@connmold.com www.connmold.com

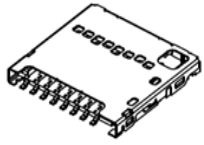
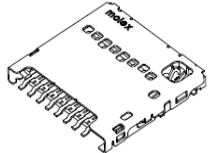
Item	Part number	photo	Description	Package	?pcs/Reel	Compatible with A	A company photo	A company part number
36	CMMSM661005		micro sim+ micro sd combo 2.28mm height	tape reel	1000	Molex		1041681620
37	CMMSM661007		micro sim card connector push push normal type	tape reel	1000	Molex		503960696
38	CMMSM661014A		micro sim push push type 1.27mm height	tape reel	1000	TE		2174803-2
39	CMMSM661015A		MICRO SIM CONNECTOR 1.45MM HEIGHT, PUSH PULL	tape reel	1500	Molex		786463001
40	CMMSM661018D		micro sim connector 1.50mm height, hinged type	tape reel	1000	Molex		788000001
41	CMNSM661004		nano sim socket 1.37mm height	tape reel	1000	TE		2336582-1

Item	Part number	photo	Description	Package	?pcs/Reel	Compatible with A	A company photo	A company part number
42	CMNSM661007		nano sim socket 1.13mm height	tape reel	2000	Molex		1042240820
43	CMNSM661008		nano sim socket 1.13mm height	tape reel	2000	GCT		SIM8051-6-0-14-01-A
44	CMNSM661018		nano sim socket 1.20mm height	tape reel	2000	Würth		693043020611
45	CMNSM6610122		nano sim BLOCK socket 6PIN 0.30mm height	tape reel	3000	Amphenol		SMB-Z520A-A00
46	CMNSM6610125		nano sim BLOCK socket 6PIN 0.30mm height	tape reel	3000	Amphenol		C70710M0086132
47	CMSIM661002		sim plastic type	tape reel	800	Amphenol		C707 10M006 500 2

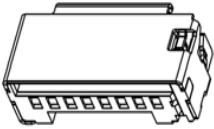
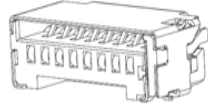
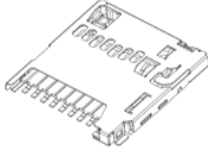
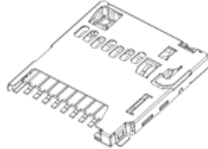
Item	Part number	photo	Description	Package	?pcs/Reel	Compatible with A	A company photo	A company part number
48	CMSIM661004		sim plastic socket yellow button 15U" Au	tape reel	500	Molex		912283001
49	CMSIM661004T		sim plastic socket yellow button 5U" Au	tape reel	500	Molex		912360001
50	CMSIM661006		sim plastic socket black button with positioning 15U" Au	tape reel	500	Molex		912283002
51	CMSIM661007		sim plastic socket	tape reel	500	Molex		912283007
52	CMSIM661007T		Tray for sim plastic socket	Bag	100	Molex		912360001
53	CMSIM661009		sim push push type with detect pin 1.80 mm height	tape reel	600	Molex		476030001

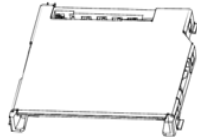
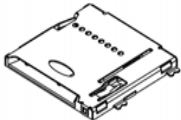
Item	Part number	photo	Description	Package	?pcs/Reel	Compatible with A	A company photo	A company part number
54	CMSIM661016		sim hinge type	tape reel	600	Molex		473882001
55	CMSIM661021		sim card 2ff no push , 2.00mm height	tape reel	1000	Molex		47308-0001
56	CMSIM661039A		sim card 2ff push , 1.95mm height with detect switch	tape reel	600	Amphenol		1010030678
57	CMMSD661001		micro sd push push type	tape reel	1000	Molex		473521001
58	CMMSD661010		micro sd push pull type 1.42mm	tape reel	2000	Molex		104031-0811







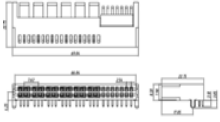
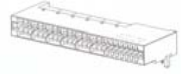

Item	Part number	photo	Description	Package	?pcs/Reel	Compatible with A	A company photo	A company part number
59	CMMSD661011		micro SD flip type	tape reel	1200	Amphenol		101-00303-xx
60	CMMSD661014		TFR header micro sd push pull type	tape reel	1500	Molex		47359-8651
61	CMMSD661022		micro sd connector push push normal type super small	tape reel	2400	Molex		503398-1892
62	CMSDS661005		SD card connector SMT type 9 positions	tape reel	400	Amphenol		GSD09001XSEU
63	CMMSD661027A		micro SD memory card connector, 1.40mm profile SMT	tape reel	1000	GCT		MEM2075-2887971

Item	Part number	photo	Description	Package	?pcs/Reel	Compatible with A	A company photo	A company part number
64	CMPEK661019EB		M.2 NGFF MINI CARD 0.50mm pitch 67 positions 4.20mm height	tape reel	940	TE		2199230-4
65	CMPEK661023MB		M.2 M KEY MINI CARD 0.50mm pitch 67 positions 4.20mm height	tape reel	940	TE		1-2199230-3
66	CMDPF661001		Display port reverse type	tape reel	390	Molex		1050190005
67	CMDPF661009		Display port normal type	tape reel	300	Molex		472720001
68	CMDPF661003E		MINI DISPLAY PORT TYPE R/A TYPE	tape reel	330	Amphenol		G46M2001421EU
69	CMDPF661003F		MINI DISPLAY PORT TYPE R/A TYPE	tape reel	330	Amphenol		G46M2001422EU

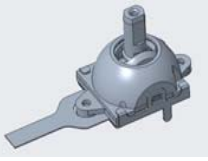
CM technology Co.,LTD---20250310 version D2

Dongguan Kangmo Electronics Co.,LTD

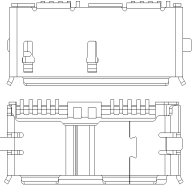
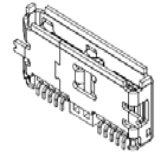

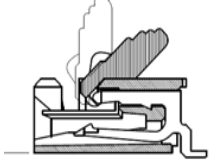
Connmold engineer immerse into this field for about 20years. Please help to contact:neal@connmold.com www.connmold.com

Item	Part number	photo	Description	Package	?pcs/Reel	Compatible with A	A company photo	A company part number
70	CMPMW661020A		36R+16S RIGHT angle power connector	TRAY	10	Amphenol		HPG36P14SRT01XX
71	CMHMF661006		HDMI A TYPE SMT Shell through hole	tape reel	480	Molex		741510051
72	CMPTM661002		hi-tech Hall potentiometer	tray	40	ALPS		RKJX21224001
73	CMMC3661003B		micro usb b 3.0 vertical type 15U" Au	tape reel	600	Mill-Max		897-10-010-00-300002
74	CMMC3661001A		micro usb 3.0 b SMT type	tape reel	1500	Amphenol		GSB343143HR
75	CMFPCxx1010B		0.5MM FPC CONN ZIF R/A Housing assembly Lower contact	tape reel	2000	MOLEX		52892-xx33

CM technology Co.,LTD---20250310 version D2

Dongguan Kangmo Electronics Co.,LTD

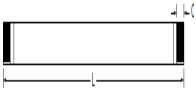
Connmold engineer immerse into this field for about 20years. Please help to contact:neal@connmold.com www.connmold.com

Item	Part number	photo	Description	Package	?pcs/Reel	Compatible with A	A company photo	A company part number
76	CMFPCxx1010B		0.5MM FPC CONN ZIF R/A Housing assembly Lower contact	tape reel	2000	Hirose		FH12-xxS-0.5SH(55)
77	CMFPCxx1012		1.0MM FPC CONN ZIF 5.35mm height	tube	1000	FCI		SLW4R 1C7LF
78	CMFFCxx1014		0.5mm center flat flex cable (FFC) flexible 105degree, Sn plated	PE bag	100	MOLEX		15166xxxx
79	CMFPCxx1015		0.50mm FPC connector, housing assembly,easy on straight type	tape reel	800	MOLEX		501951xx00
80	CMFPCxx1021		1.00mm FPC SMT ZIF horizontal hinge type	tape reel	2000	Wurth		686110148922
81	CMFPCxx1023		0.50mm pitch FPC SMT R/A Bottom contact	tape reel	2000	MOLEX		54132XX62

CM technology Co.,LTD---20250310 version D2

Dongguan Kangmo Electronics Co.,LTD

Connmold engineer immerse into this field for about 20years. Please help to contact:neal@connmold.com www.connmold.com

Item	Part number	photo	Description	Package	?pcs/Reel	Compatible with A	A company photo	A company part number
82	CMFPCxx1029		0.50mm pitch FPC SMT R/A 2.55H with lock type	tape reel	1500	kyocera		6288-2820237
83	CMFPCxx1031		0.50mm pitch FPC SMT R/A 1.75H with lock type	tape reel	2500	molex		5052782233
84	CMFPCxx1036		0.30mm FPC connector, housing assembly,Back flip type	tape reel	5000	molex		502598xx93
85	CMFPCxx1039A		1.00mm FPC connector, housing assembly,horizontal hinge type	tape reel	2500	molex		200528-0140
86	CMBTBXX1033		Floating board to board plug	tape reel	500	Hirose		FX23L-xxP-0.5SV8
87	CMBTBXX1034		Floating board to board socket	tape reel	500	Hirose		FX23L-xxS-0.5SV

CM technology Co.,LTD---20250310 version D2

Dongguan Kangmo Electronics Co.,LTD

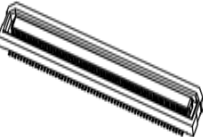

Connmold engineer immerse into this field for about 20years. Please help to contact:neal@connmold.com www.connmold.com

Item	Part number	photo	Description	Package	?pcs/Reel	Compatible with A	A company photo	A company part number
88	CMFPCxx1062A		FPC 0.50mm pitch ZIF bottom contact	tape reel	2000	molex		545482272
89	CMFPCxx1063A		FPC 0.50mm pitch ZIF upper contact	tape reel	2000	molex		545500672
90	CMBTBxxx1070A		Board to board 0.50mm pitch 5.00mm height	tape reel	1000	Samtec		LSHM-120-02.5-L-DV-A-S-K
91	CMBTBXX1071A		Board to board header 0.50mm pitch 3.00mm height with boss	tape reel	1000	Panasonic	 4,6mm Header	AXK5xx337YG
92	CMBTBXX1071B		Board to board socket 0.50mm pitch 3.00mm height with boss	tape reel	1000	Panasonic	 P5K 5,8mm Socket	AXK5xx137YG
93	CMBTBXX1072A		Board to board header 0.50mm pitch 3.00mm height without boss	tape reel	1000	Panasonic	 4,6mm Header	AXK5xx347YG

CM technology Co.,LTD---20250310 version D2

Dongguan Kangmo Electronics Co.,LTD

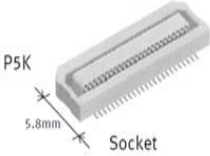
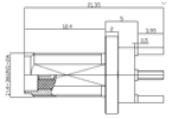
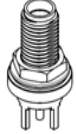
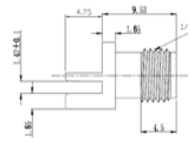
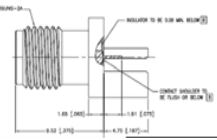
Connmold engineer immerse into this field for about 20years. Please help to contact:neal@connmold.com www.connmold.com

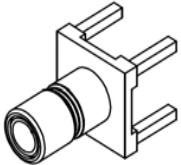
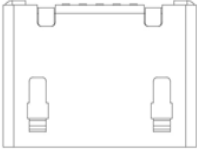
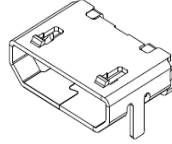
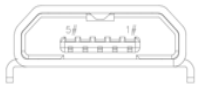
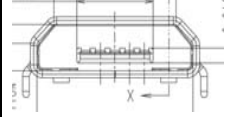
Item	Part number	photo	Description	Package	?pcs/Reel	Compatible with A	A company photo	A company part number
94	CMBTBXX1072B		Board to board socket 0.50mm pitch 3.00mm height without boss	tape reel	1000	Panasonic		AXK5xx147YG
95	CMSMA661002		SMA PCB THT JACK 50 OHMS IP67	PE bag	100	Würth		60312052111533
96	CMSMA661005B		SMA end launch receptacle	PE bag	100	Amphenol		132414
97	CMSMB661004		SMB jack VERTICAL 75Ω	PE bag	100	Molex		731000157
98	CMMCF661006		micro USB B TYPE SOCKET 7.15mm W/O flange W/O positioning	tape reel	1000	GCT		USB3076-30-A
99	CMMCF661009		micro USB B TYPE receptacle 7.90 W/O flange reverse type	tape reel	1500	TE		1932788-1

CM technology Co.,LTD---20250310 version D2

Dongguan Kangmo Electronics Co.,LTD

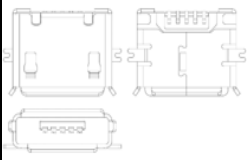
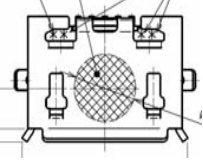
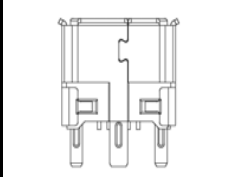
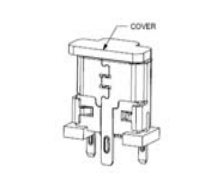
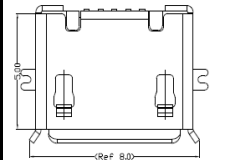
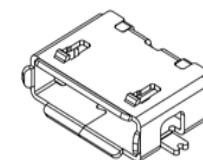
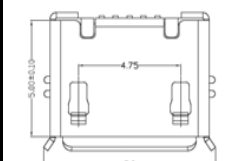
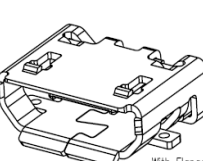
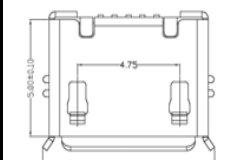
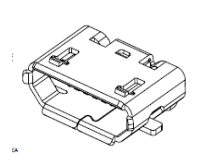
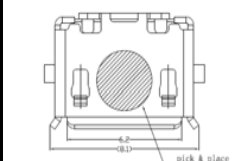
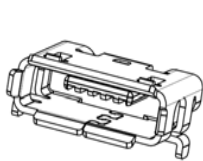

Connmold engineer immerse into this field for about 20years. Please help to contact:neal@connmold.com www.connmold.com

Item	Part number	photo	Description	Package	?pcs/Reel	Compatible with A	A company photo	A company part number
100	CMMCF661017		micro usb AB type Right angle	tape reel	1500	Hirose		ZX62-AB-5PA
101	CMMCF661012		micro usb B type receptacle vertical angle	tape reel	500	Molex		105133 0021
102	CMMCF661017		micro usb AB type SMT	tape reel	1500	Hirose		ZX62-AB-5PA
103	CMMCF661020		micro usb B type SMT	tape reel	1500	FCI		10118192
104	CMMCF661020A		micro usb B type SMT	tape reel	1500	MOLEX		473460001
105	CMMCF661036B		micro usb AB type SMT	tape reel	1500	Molex		475890001

CM technology Co.,LTD---20250310 version D2

Dongguan Kangmo Electronics Co.,LTD

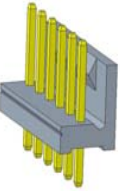
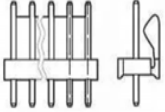

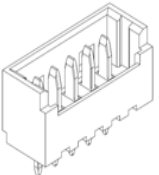
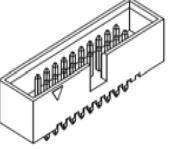
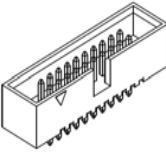
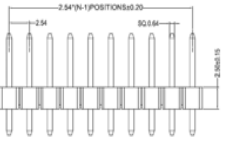
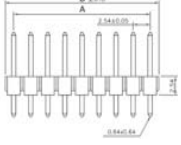
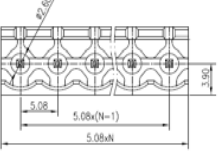
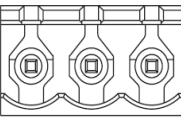
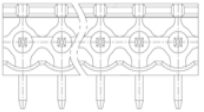
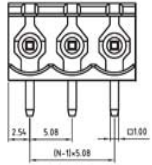

Connmold engineer immerse into this field for about 20years. Please help to contact:neal@connmold.com www.connmold.com

Item	Part number	photo	Description	Package	?pcs/Reel	Compatible with A	A company photo	A company part number
106	CMPHMxx1006		Wafer 2.54 mm pitch with polarized Notched	PE bag	3000	TE		640456-6
107	CMPHMxx1021		1.25mm pitch Header Assembly DIP TIN Plating type	PE bag	1000	Molex		53047xx10
108	CMPHMxx1022		1.27mm pitch box header dual row stright type	PE bag	2000	Wurth		6270162xx21
109	CMPHMxx1023		2.54mm pitch pin header stright type	PE bag	2000	Wurth		6130021xx21
110	CMPHMxx1024		5.08mm pitch terminal block vertical type	PE bag	100	Wurth		691 311 500 0xx
111	CMPHMxx1025		5.08mm pitch terminal block right angle type	PE bag	100	Wurth		691 312 510 0xx

CM technology Co.,LTD---20250310 version D2

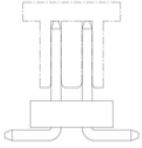
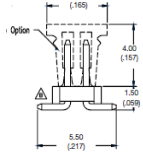
Dongguan Kangmo Electronics Co.,LTD

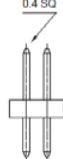
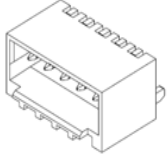
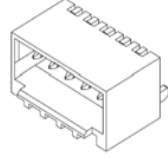
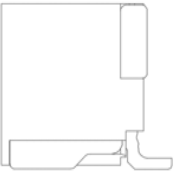
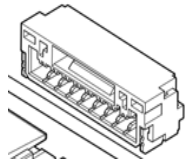

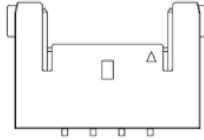
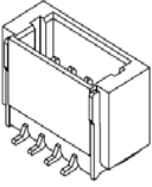
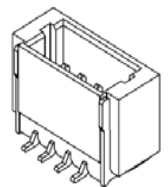

Connmold engineer immerse into this field for about 20years. Please help to contact:neal@connmold.com www.connmold.com

Item	Part number	photo	Description	Package	?pcs/Reel	Compatible with A	A company photo	A company part number
112	CMPHMxx1026		1.27MM pitch PIN header dual row SMT type	tape reel	1000	FCI		20021121-000xxC4LF
113	CMPHMxx1028		1.27MM pitch PIN header dual row straight type	box	2000	Wurth		6220xx21121
114	CMWAFxx10062		1.50MM pitch wafer header 4.45MM right angel type wire to board header	tape reel	1000	molex		87438xx43
115	CMWAFxx1007		1.25mm pitch Waer Header Assembly right angle type	tape reel	1000	JST		SMxxB-GHS-TB
116	CMWAFxx1009		WAFER 1.50 pitch 4pin	tape reel	2000	Molex		504050xx91
117	CMWAFxx1010		1.00mm pitch WAFER vertical type	tape reel	1000	fci		10147605-000xxLF

CM technology Co.,LTD---20250310 version D2

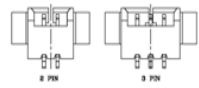
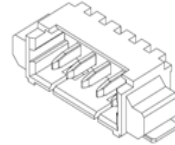
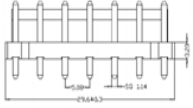
Dongguan Kangmo Electronics Co.,LTD

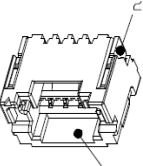
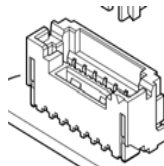
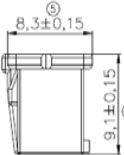
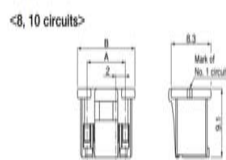
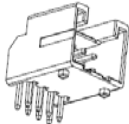
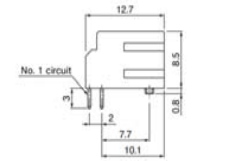





Connmold engineer immerse into this field for about 20years. Please help to contact:neal@connmold.com www.connmold.com

Item	Part number	photo	Description	Package	?pcs/Reel	Compatible with A	A company photo	A company part number	
124	CMWAFxx1053A		1.25mm pitch wafer 3.50mm height	tape reel	2000	Molex		532610471	
125	CMWAFxx1055B		5.08mm pitch wafer 14.60mm	PE bag	1000	TE		1744037-5	
126	CMWAFxx1057A		1.50pitch wafer vertical	tape reel	1000	JST		BM09B-ZESS-TBT	
127	CMWAFxx1058F		2.00mm pitch housing	PE bag	1000	JST		<8, 10 circuits>	PUDP-30V-S
128	CMWAFxx1058H		2.00mm pitch wafer right angle through hole type	PE bag	1000	JST		SXXB-PUDSS-1	
129	CMWAFxx1059E		2.54mm pitch singel row straight shrouded header	PE bag	500	Molex		901361108	

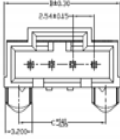
CM technology Co.,LTD---20250310 version D2

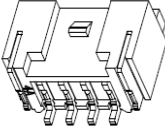
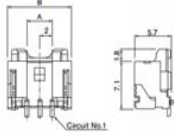
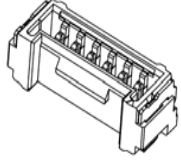
Dongguan Kangmo Electronics Co.,LTD

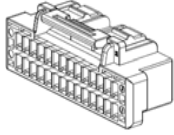
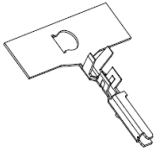
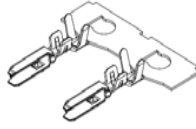
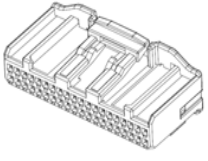

Connmold engineer immerse into this field for about 20years. Please help to contact:neal@connmold.com www.connmold.com

Item	Part number	photo	Description	Package	?pcs/Reel	Compatible with A	A company photo	A company part number
130	CMWAFxx1066A		2.54mm crimp type SMT gold plated	tape reel	250	TE		5-147278-3
131	CMWAFxx1067B		2.00mm wafer single row SMT h=5.70mm	tape reel	1000	JST		SM03B-PASS-TBT
132	CMWAFxx1073B		1.25mm pitch vertical type	tape reel	1200	molex		5055681070
133	CMHSGxx1002		1.50mm pitch housing	PE bag	1000	Molex		503149xx00
134	CMTML661003		1.50mm pitch terminal	reel	5000	Molex		2025790000
135	CMHSG401004		2.20mm pitch housing white	PE bag	1000	TE		1318389-1

CM technology Co.,LTD---20250310 version D2

Dongguan Kangmo Electronics Co.,LTD

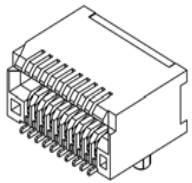
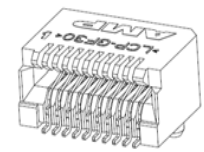
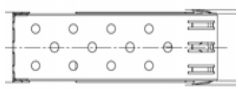
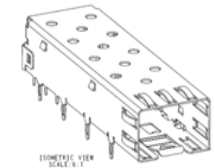
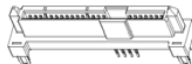

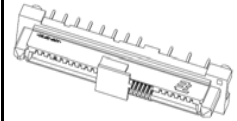
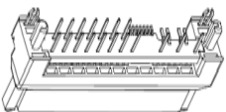
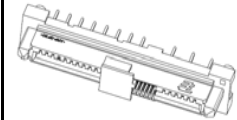
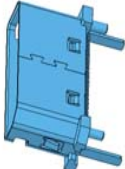
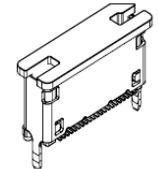

Connmold engineer immerse into this field for about 20years. Please help to contact:neal@connmold.com www.connmold.com

Item	Part number	photo	Description	Package	?pcs/Reel	Compatible with A	A company photo	A company part number
136	CMSFP661001		SFP 20P 1X1 0.80mm pitch	tape reel	600	TE		1367073-1
137	CMSFP661002		SFP Cage Press-fit type	tray	264	TE		2227302-1
138	CMSAS661004		SAS 29PIN dip press fit type	tube	200	TE		1735164-1
139	CMSAS661005		SAS 29pin vertical receptacle SMT+DIP hybrid type	tube	200	TE		1735104-1
140	CMSAS661007		SAS 29pin vertical receptacle SMT+DIP hybrid type 4.00mm	tube	200	TE		1735104-4
141	CMSAS661008		nano pitch vertical 42pin receptacle	tape reel	500	Molex		171983-2642

CM technology Co.,LTD---20250310 version D2

Dongguan Kangmo Electronics Co.,LTD

Connmold engineer immerse into this field for about 20years. Please help to contact:neal@connmold.com www.connmold.com

Item	Part number	photo	Description	Package	?pcs/Reel	Compatible with A	A company photo	A company part number
142	CMLVS661009		0.50pitch 30pin LVDS connector	tape reel	4000	IPEX		20525-130E-01
143	CMSAS661011A		68pin connector vertical SMT receptacle	tape reel	350	Amphenol		PSAS5F3130051TR

More product are on their way, if you need anything ,please feel free to contact Mr. Neal, his email is :Neal@connmold.com
 More product are on their way, if you need anything ,please feel free to contact Mr. Charles, his email is :connmold@163.com